

P1

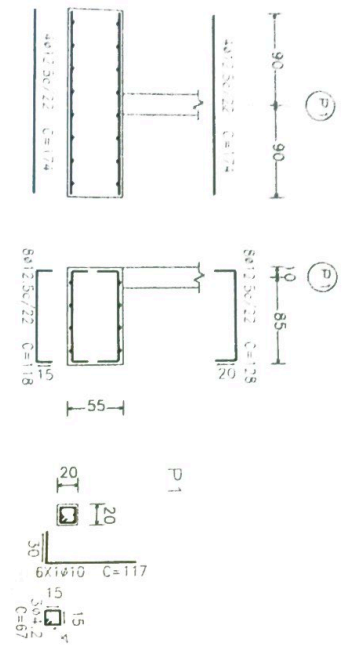

(P2-P10) e (P4-P11)

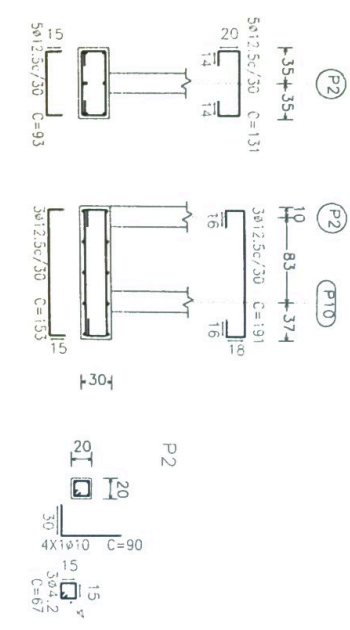

P3

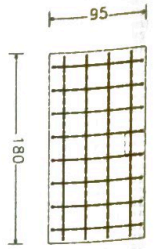
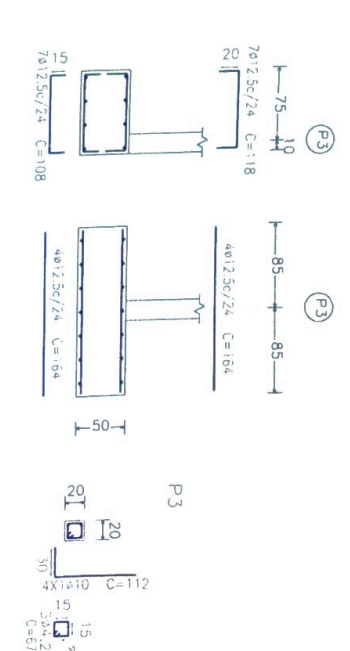

P5

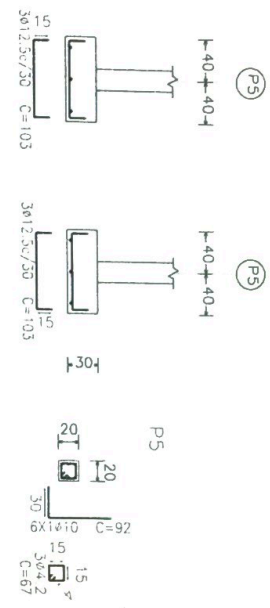

P6

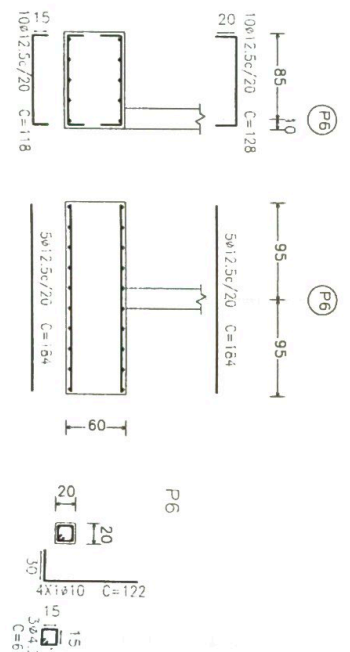

P10



P6

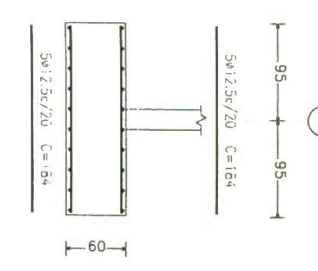

P6

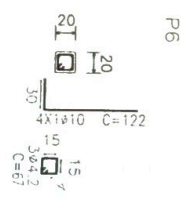

P7

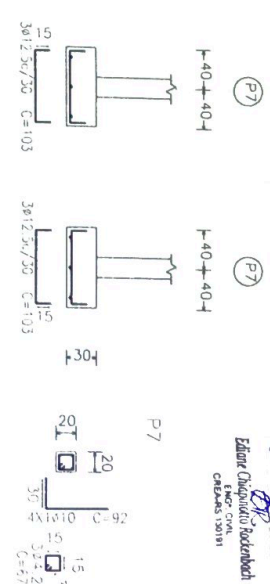
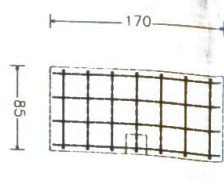

P7

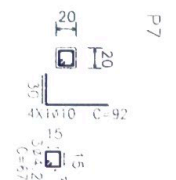

P8, P9 e P21

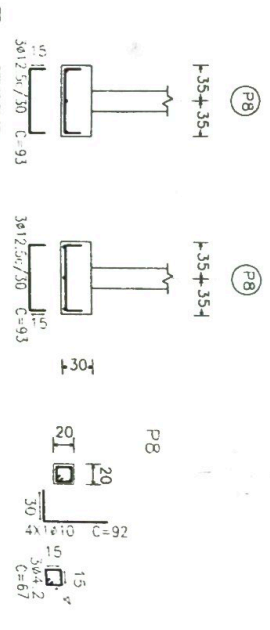

P8

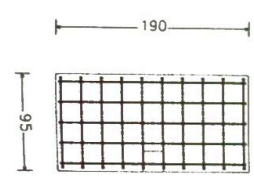
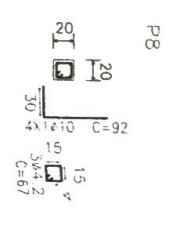

PREFEITURA MUNICIPAL DE CANDÓDIA

SECRETARIA DE OBRAS
 VALDIR DE OLIVEIRA

SECRETARIA DE TRÁFICO
 VICTOR FORTES

SECRETARIA DE PLANEJAMENTO
 ODET 2021

SECRETARIA DE FINANÇAS
 INDICAÇÃO

SECRETARIA DE ADMINISTRAÇÃO
 ESTRUTURAL - FUNDACOES 02

Prefeitura Municipal de Candódia
 CNPJ: 04.740.701-08

APROVADO

08/11/2021

Marcelo Vitor Leal
 ENO - CNIL
 OREA 85780

Prefeitura Municipal de Candódia
 CNPJ: 04.740.701-08

APROVADO

08/11/2021

Edmar Chiquinho Rodenbeck
 ENO - CNIL
 OCREAS 150191